

50 G-90 1F

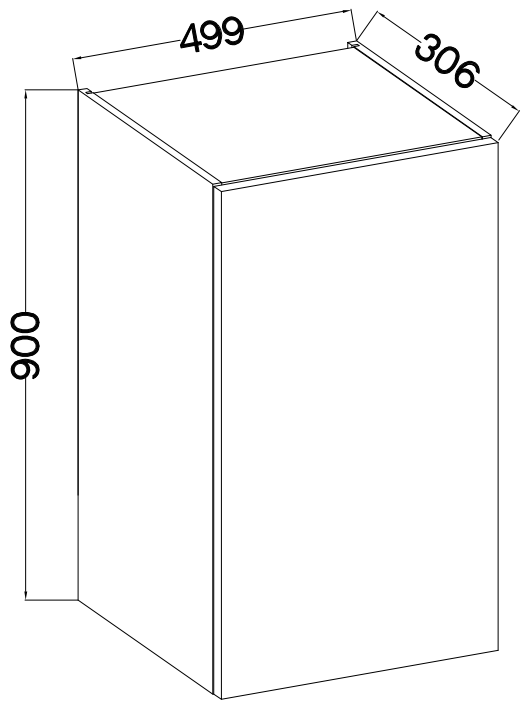

max. 5kg
KUH.30001
KUH.40001

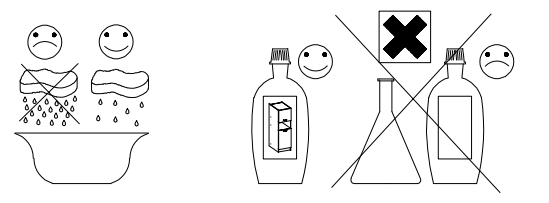

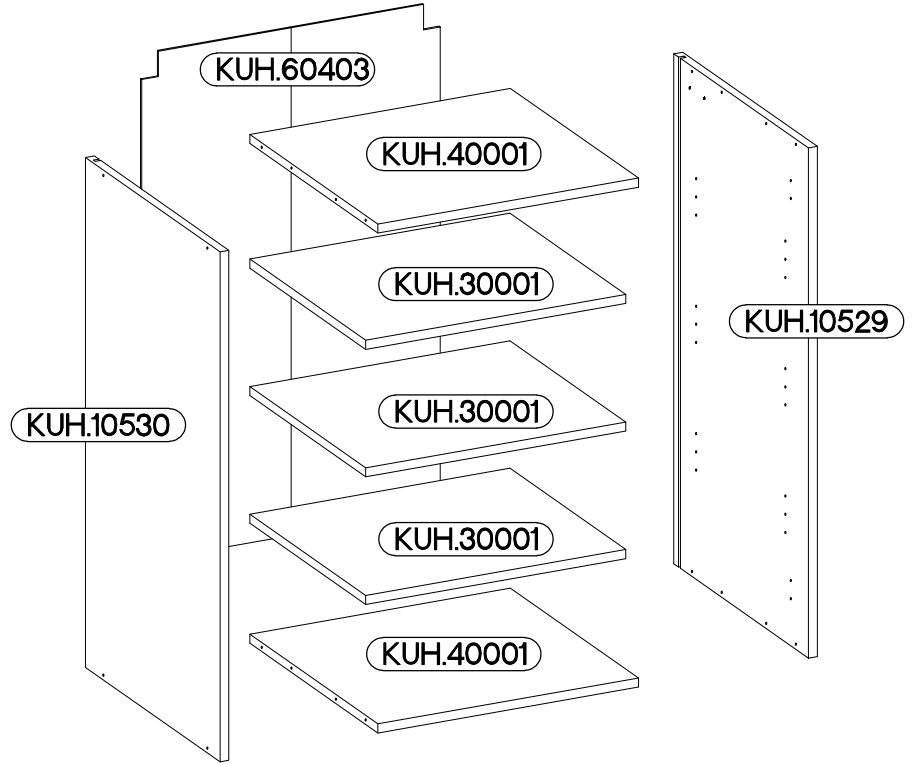
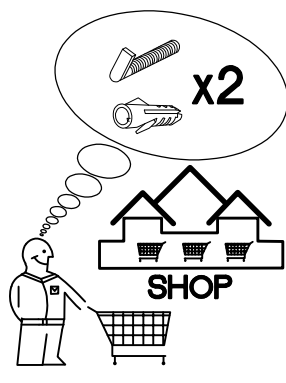
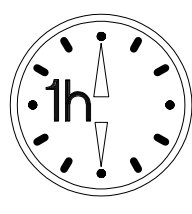

Ersatzteil Nummer	Dimension
KUH.10529	900x290x16
KUH.10530	900x290x16
KUH.30001 x3	466x250x16
KUH.40001 x2	467x276x16
KUH.60403	896x485x2,5

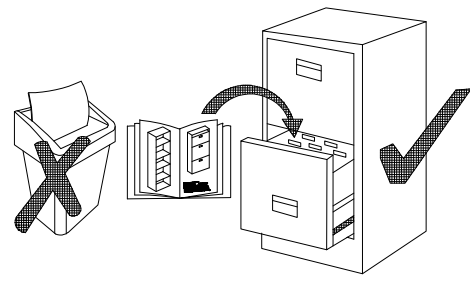
±8x30mm A	6,4 x 50mm B	E1	±35/0mm [CD] HG	±5/19mm J	
8	8	8	2	12	
L	R	O	±3.5x13mm P5	±3.0x20mm P7	±4.0x30mm P8
K25	K26	O	4	8-10	4
1	1	1			



ISM-KUH-01820

1

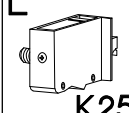
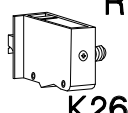
 ±8x30mm A	 ±4.0x30mm P8	 L K25	 R K26
8	4	1	1

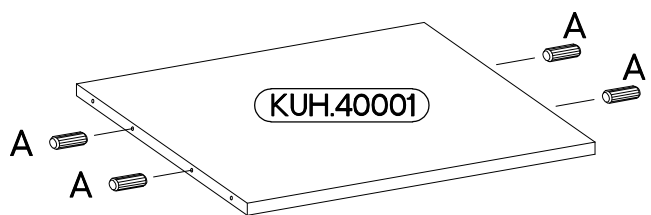
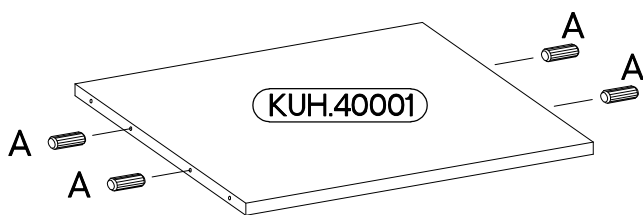
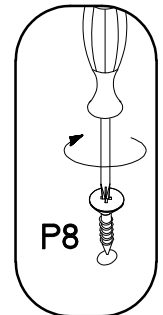
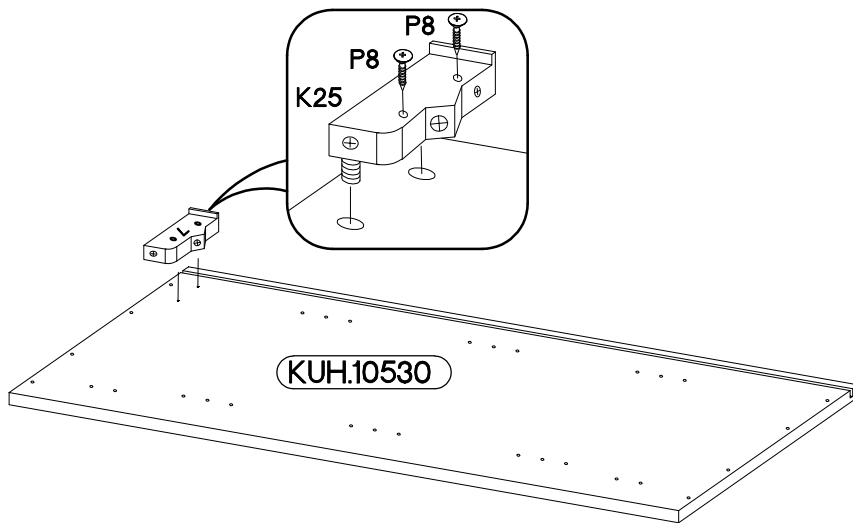
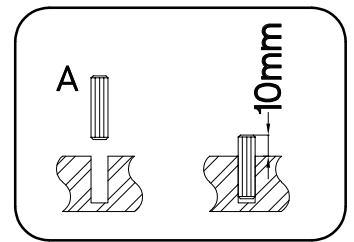
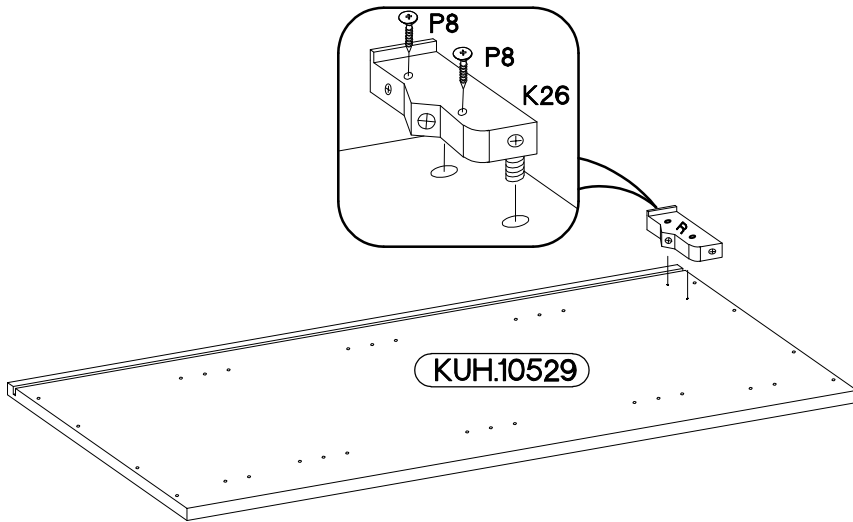
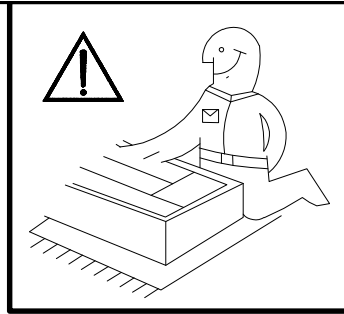

2

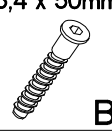
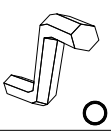
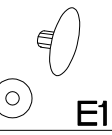
6,4 x 50mm		
		
B	O	E1
4	1	4

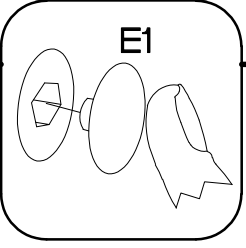
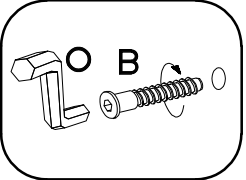
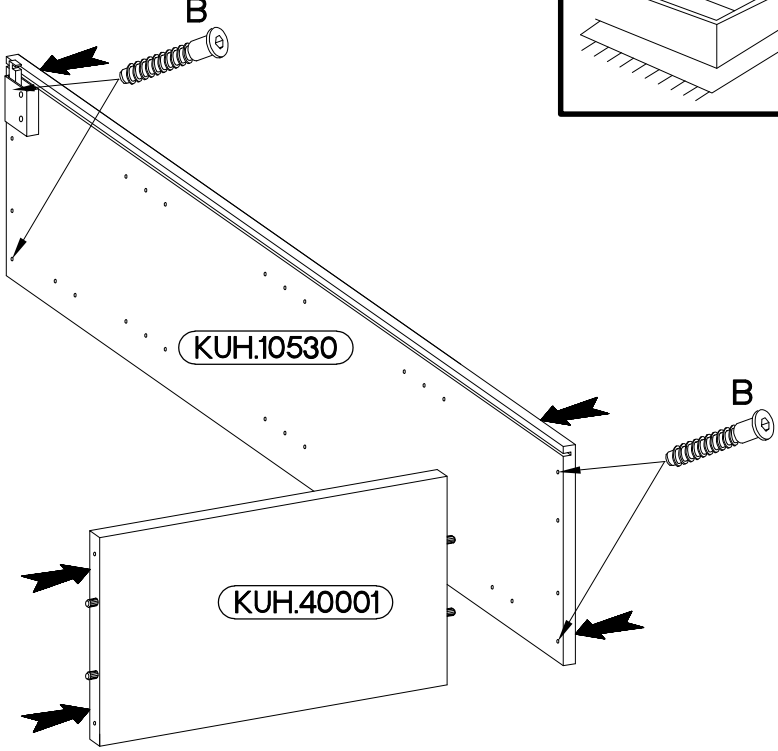
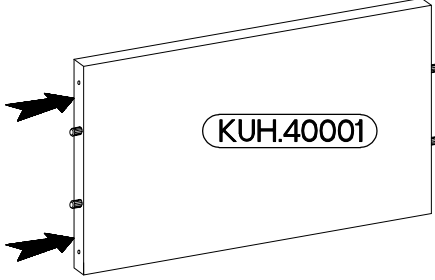
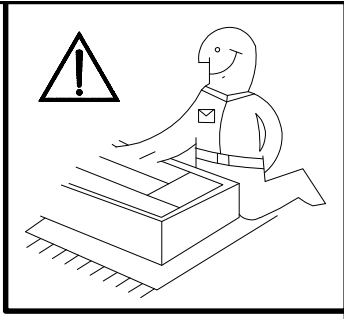

3

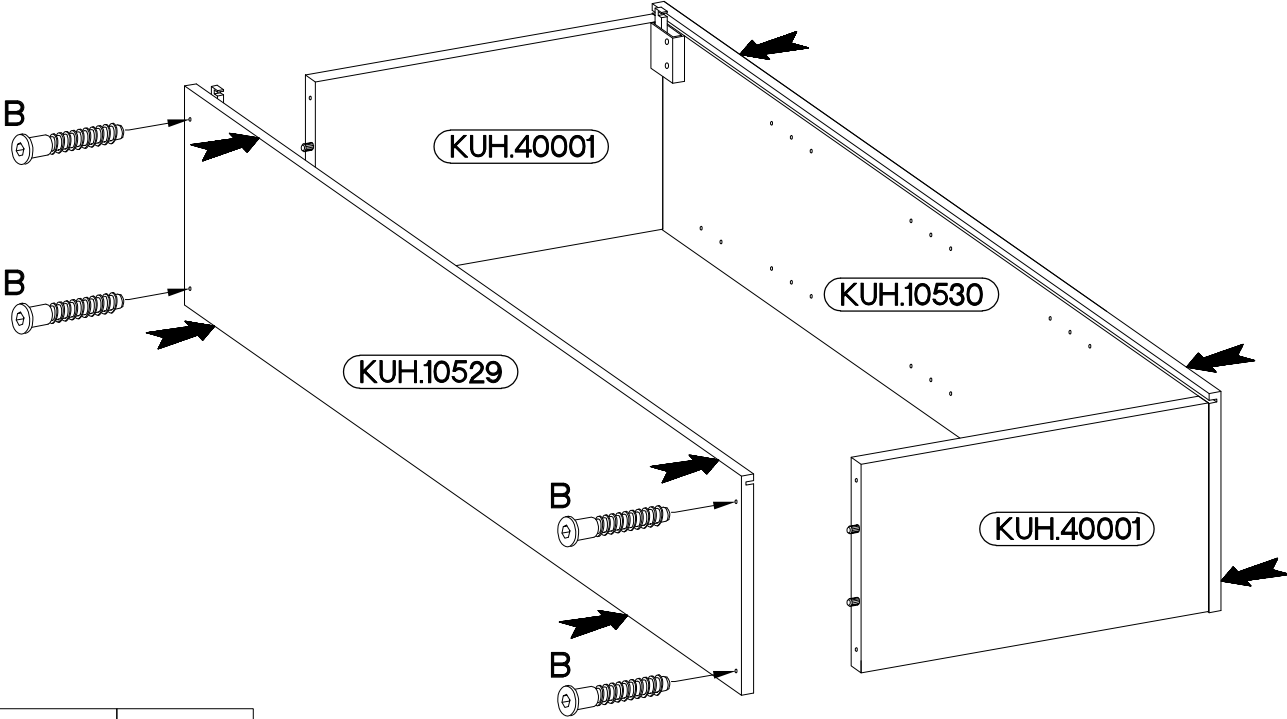

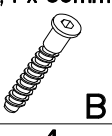
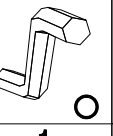
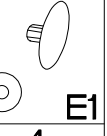
6,4 x 50mm		
		
B	O	E1
4	1	4

4

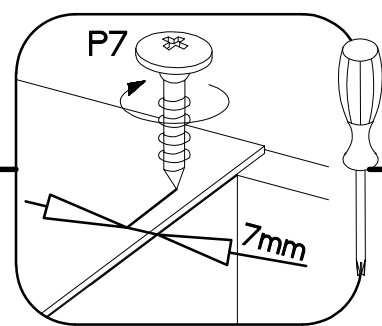
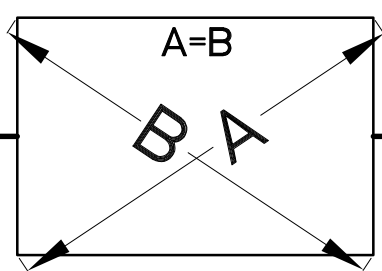
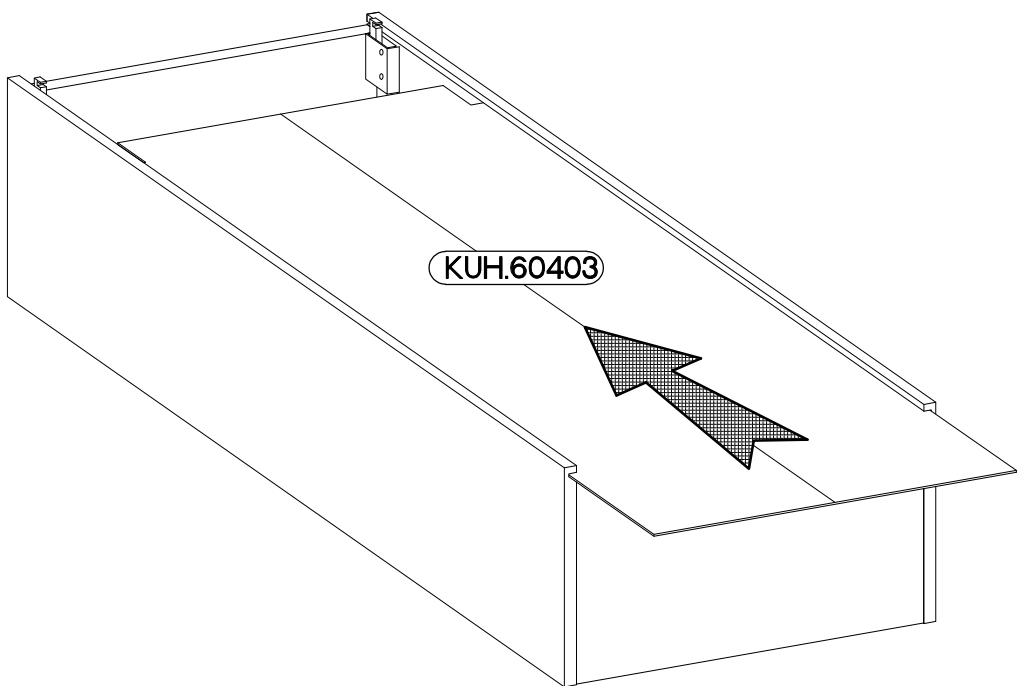
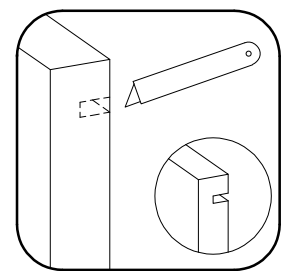
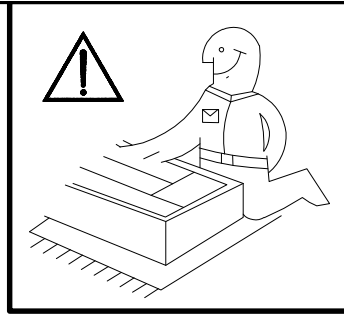

5

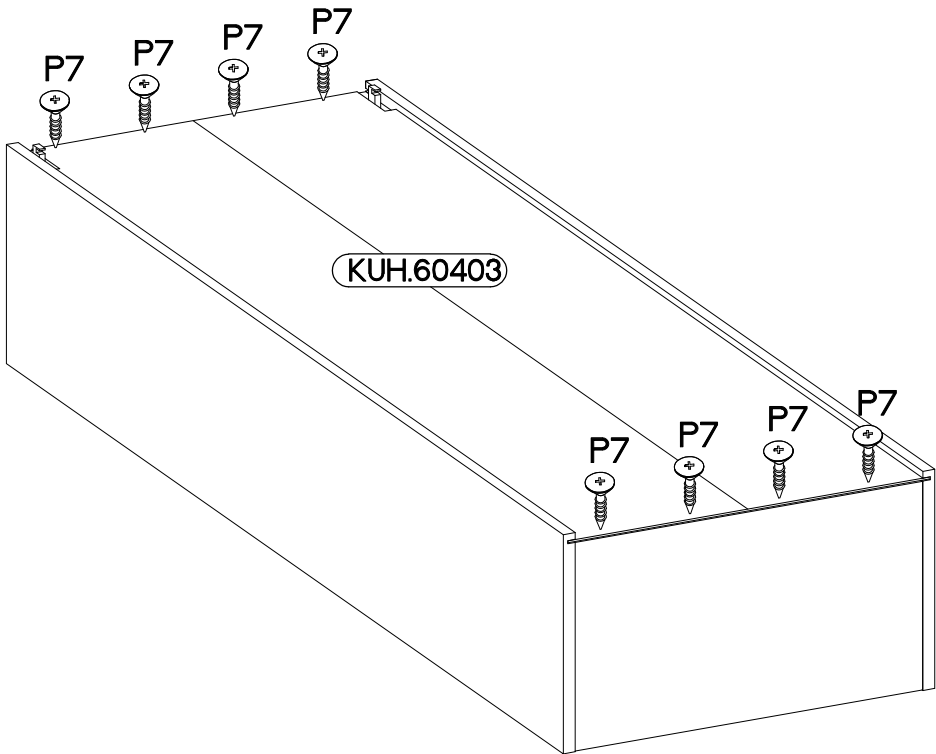
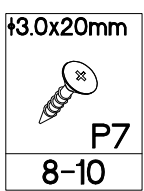

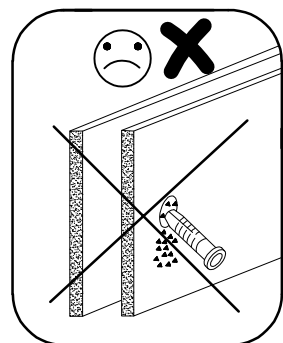
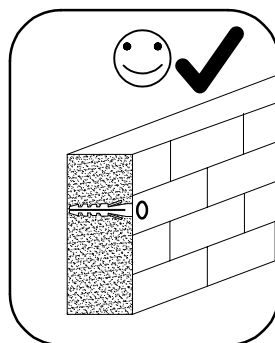
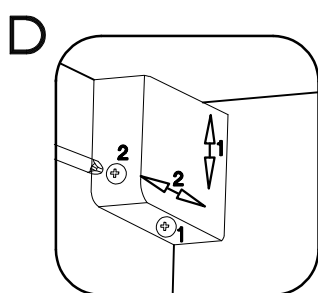
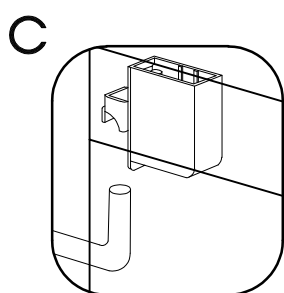
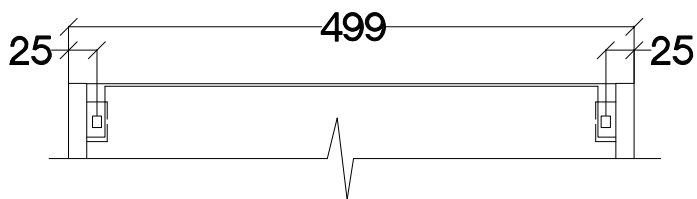
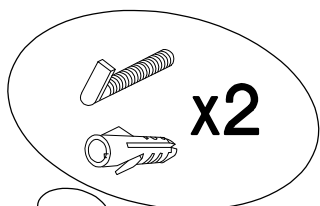
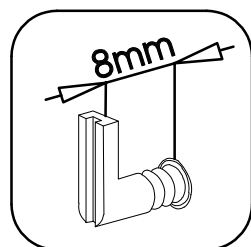
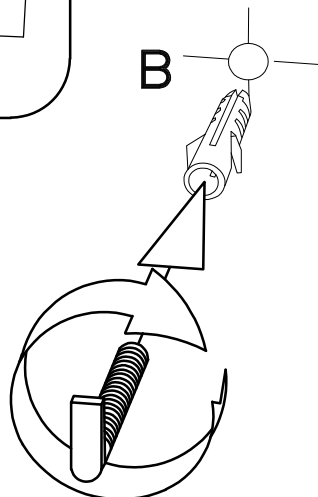
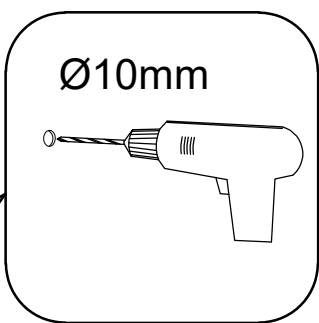
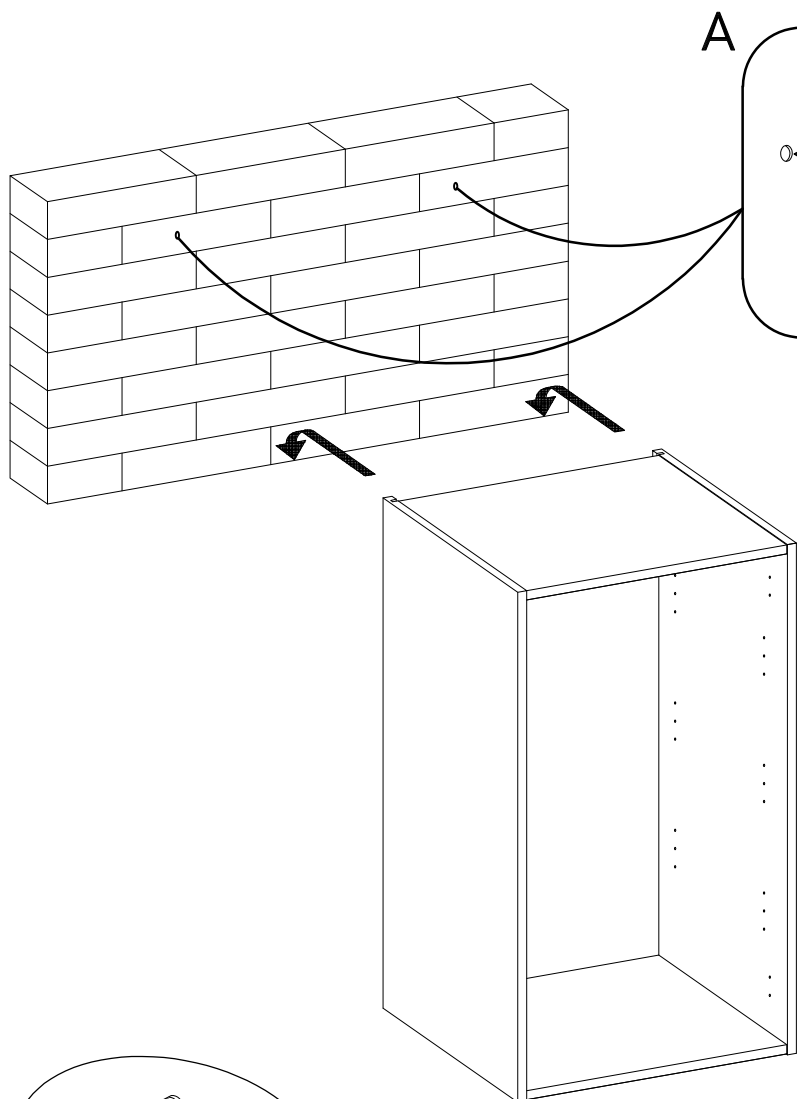
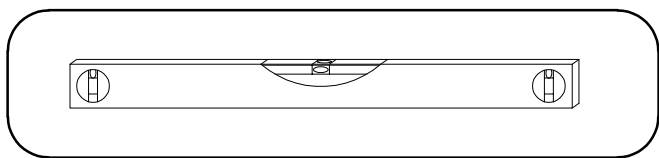

7

±5/19mm
J
12

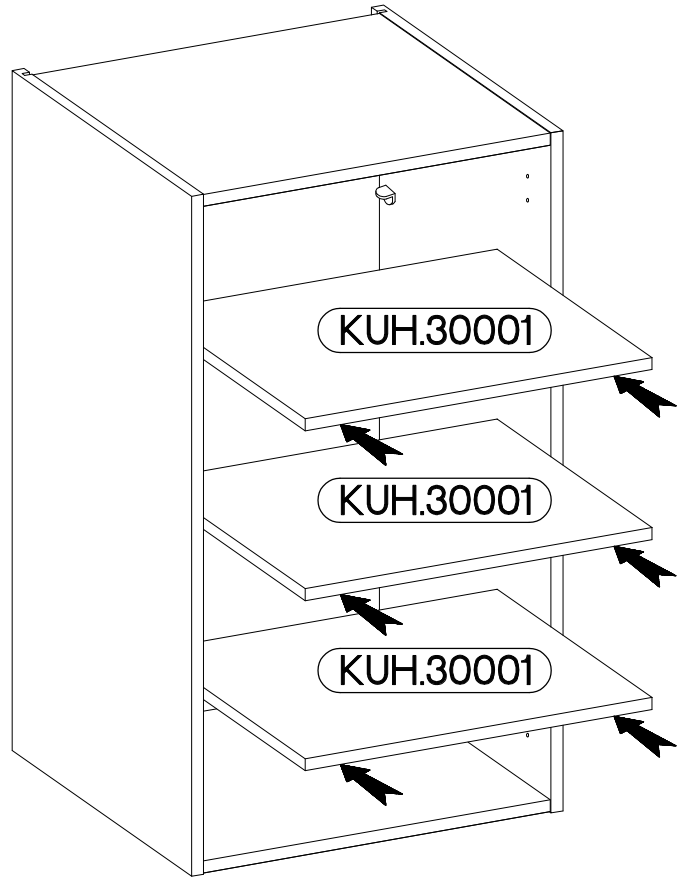
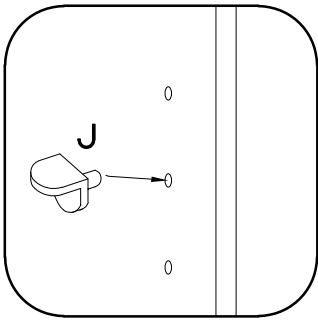

8

FRONT

